

**15A, 50V, 0.140 Ohm, Logic Level N-Channel Power MOSFETs**

These are N-Channel enhancement mode silicon gate power field effect transistors designed for applications such as switching regulators, switching converters, motor drivers, relay drivers and drivers for high power bipolar switching transistors requiring high speed and low gate drive power. These types can be operated directly from integrated circuits.

Formerly developmental type TA0522.

**Ordering Information**

PART NUMBER	PACKAGE	BRAND
RFP15N05L	TO-220AB	RFP15N05L

NOTE: When ordering, use the entire part number.

**Features**

- 15A, 50V
- $r_{DS(ON)} = 0.140\Omega$
- Design Optimized for 5V Gate Drives
- Can be Driven from QMOS, NMOS, TTL Circuits
- Compatible with Automotive Drive Requirements
- SOA is Power Dissipation Limited
- Nanosecond Switching Speeds
- Linear Transfer Characteristics
- High Input Impedance
- Majority Carrier Device
- Related Literature
  - TB334 "Guidelines for Soldering Surface Mount Components to PC Boards"

**Symbol**

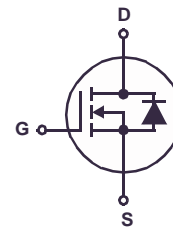

**Packaging**

**JEDEC TO-220AB**

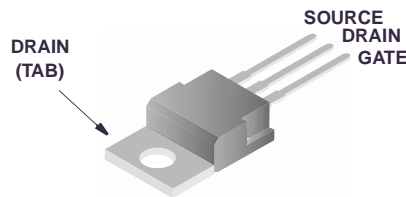

# RFP15N05L

## Absolute Maximum Ratings $T_C = 25^\circ\text{C}$ , Unless Otherwise Specified

Parameter	Ratings	Units
Drain to Source Voltage (Note 1) . . . . .	$V_{DSS}$	50 V
Drain to Gate Voltage ( $R_{GS} = 20k\Omega$ ) (Note 1) . . . . .	$V_{DGR}$	50 V
Continuous Drain Current . . . . .	$I_D$	15 A
Pulsed Drain Current (Note 3) . . . . .	$I_{DM}$	40 A
Gate to Source Voltage . . . . .	$V_{GS}$	$\pm 10$ V
Maximum Power Dissipation . . . . .	$P_D$	60 W
Above $T_C = 25^\circ\text{C}$ , Derate Linearly . . . . .		0.48 W/ $^\circ\text{C}$
Operating and Storage Temperature . . . . .	$T_J, T_{STG}$	-55 to 150 $^\circ\text{C}$
Maximum Temperature for Soldering		
Leads at 0.063in (1.6mm) from Case for 10s . . . . .	$T_L$	300 $^\circ\text{C}$
Package Body for 10s, See Techbrief 334 . . . . .	$T_{pkg}$	260 $^\circ\text{C}$

CAUTION: Stresses above those listed in "Absolute Maximum Ratings" may cause permanent damage to the device. This is a stress only rating and operation of the device at these or any other conditions above those indicated in the operational sections of this specification is not implied.

### NOTE:

- $T_J = 25^\circ\text{C}$  to  $125^\circ\text{C}$ .

## Electrical Specifications $T_C = 25^\circ\text{C}$ , Unless Otherwise Specified

PARAMETER	SYMBOL	TEST CONDITIONS	MIN	TYP	MAX	UNITS
Drain to Source Breakdown Voltage	$BV_{DSS}$	$I_D = 250\mu\text{A}, V_{GS} = 0\text{V}$	50	-	-	V
Gate Threshold Voltage	$V_{GS(TH)}$	$V_{GS} = V_{DS}, I_D = 250\mu\text{A}$ (Figure 7)	1	-	2	V
Zero Gate Voltage Drain Current	$I_{DSS}$	$V_{DS} = 48\text{V}, V_{GS} = 50\text{V}$	-	-	1	$\mu\text{A}$
		$V_{DS} = 48\text{V}, V_{GS} = 50\text{V}$ $T_C = 125^\circ\text{C}$	-	-	50	$\mu\text{A}$
Gate to Source Leakage Current	$I_{GSS}$	$V_{GS} = \pm 10\text{V}, V_{DS} = 0\text{V}$	-	-	100	nA
Drain to Source On Resistance (Note 2)	$r_{DS(ON)}$	$I_D = 15\text{A}, V_{GS} = 5\text{V}$ (Figures 5, 6)	-	-	0.140	$\Omega$
Input Capacitance	$C_{ISS}$	$V_{DS} = 25\text{V}, V_{GS} = 0\text{V}, f = 1\text{MHz}$ (Figure 8)	-	-	900	pF
Output Capacitance	$C_{OSS}$		-	-	450	pF
Reverse-Transfer Capacitance	$C_{RSS}$		-	-	200	pF
Turn-On Delay Time	$t_{d(ON)}$	$V_{DD} = 30\text{V}, I_D = 7.5\text{A}, R_G = 6.25\Omega$ (Figures 10, 11)	-	16	40	ns
Rise Time	$t_r$		-	250	325	ns
Turn-Off Delay Time	$t_{d(OFF)}$		-	200	325	ns
Fall Time	$t_f$	$V_{GS} = 5\text{V}$	-	225	325	ns
Thermal Resistance Junction to Case	$R_{\theta JC}$		-	-	2.083	$^\circ\text{C/W}$

## Source to Drain Diode Specifications

PARAMETER	SYMBOL	TEST CONDITIONS	MIN	TYP	MAX	UNITS
Source to Drain Diode Voltage (Note 2)	$V_{SD}$	$I_{SD} = 7.5\text{A}$	-	-	1.4	V
Diode Reverse Recovery Time	$t_{rr}$	$I_{SD} = 4\text{A}, dI_{SD}/dt = 100\text{A}/\mu\text{s}$	-	225	-	ns

### NOTE:

- Pulsed: pulse duration =  $\leq 300\mu\text{s}$  maximum, duty cycle =  $\leq 2\%$ .
- Repetitive rating: pulse width limited by maximum junction temperature.

Typical Performance Curves Unless Otherwise Specified

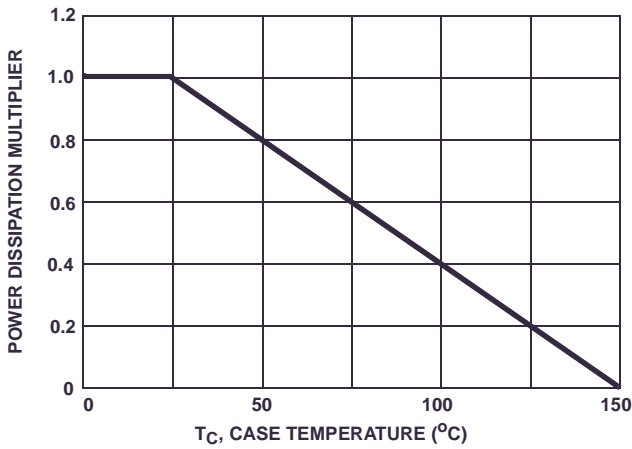

FIGURE 1. NORMALIZED POWER DISSIPATION vs CASE TEMPERATURE

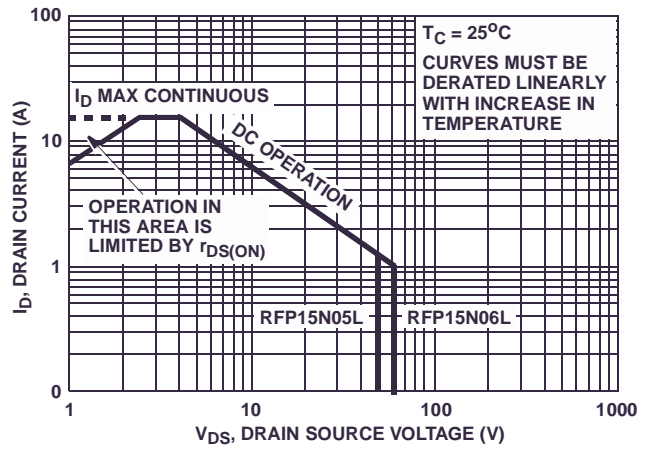

FIGURE 2. FORWARD BIAS SAFE OPERATING AREA

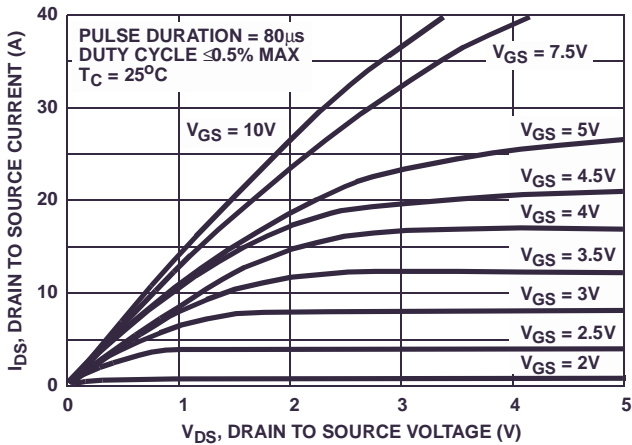

FIGURE 3. SATURATION CHARACTERISTICS

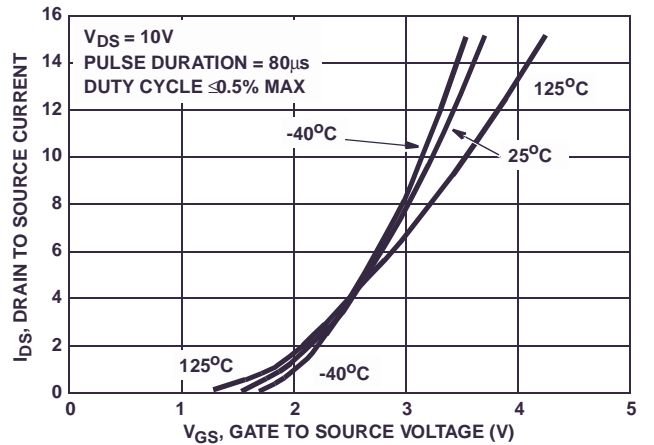

FIGURE 4. TRANSFER CHARACTERISTICS

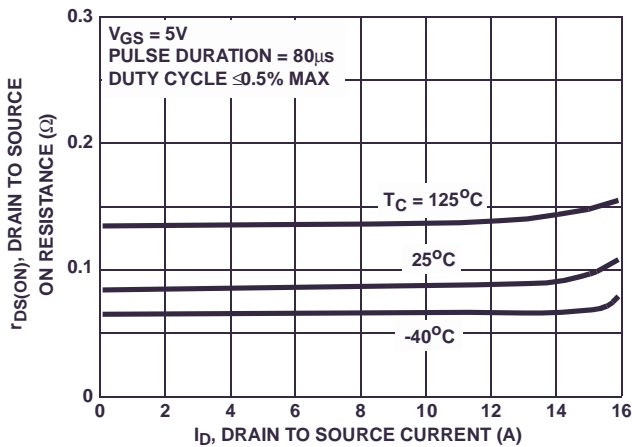

FIGURE 5. DRAIN TO SOURCE ON RESISTANCE vs DRAIN CURRENT

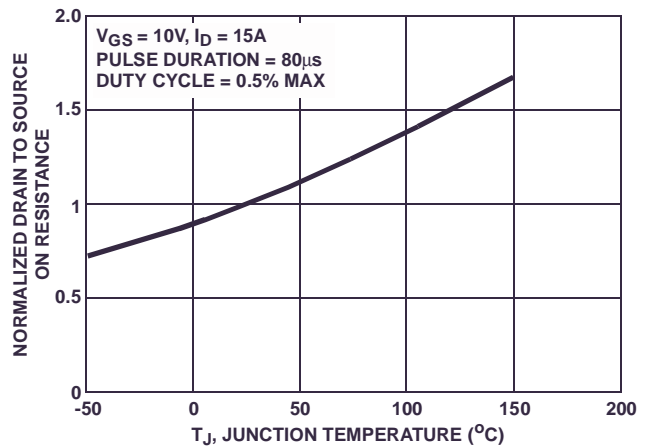

FIGURE 6. NORMALIZED DRAIN TO SOURCE ON RESISTANCE vs JUNCTION TEMPERATURE

Typical Performance Curves Unless Otherwise Specified (Continued)

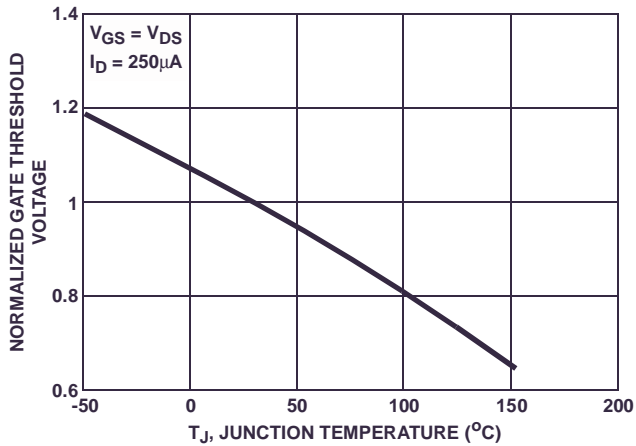

FIGURE 7. NORMALIZED GATE THRESHOLD VOLTAGE vs JUNCTION TEMPERATURE

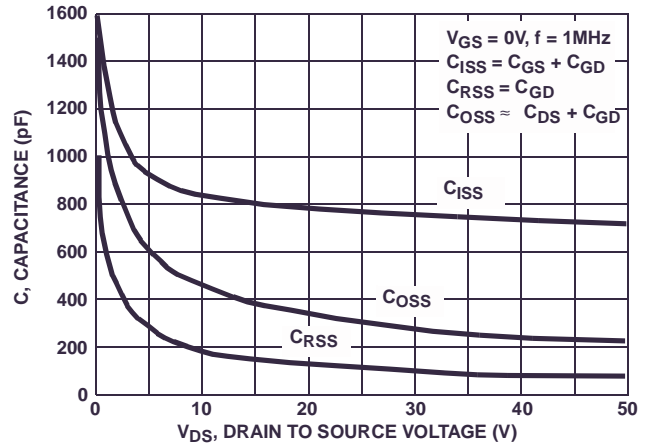
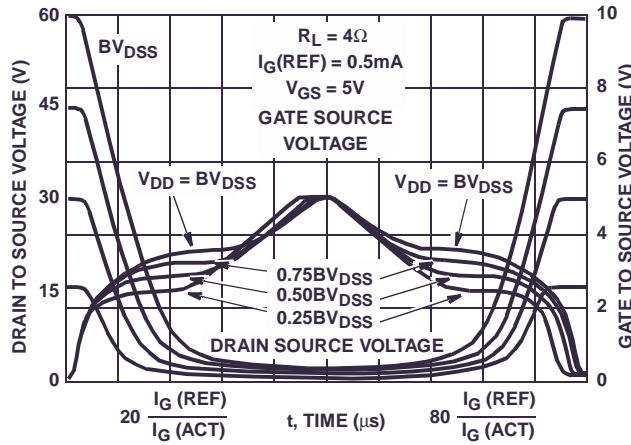

FIGURE 8. CAPACITANCE vs DRAIN TO SOURCE VOLTAGE



NOTE: Refer to Fairchild Application Notes AN7254 and AN7260.

FIGURE 9. NORMALIZED SWITCHING WAVEFORMS FOR CONSTANT GATE CURRENT

Test Circuits and Waveforms

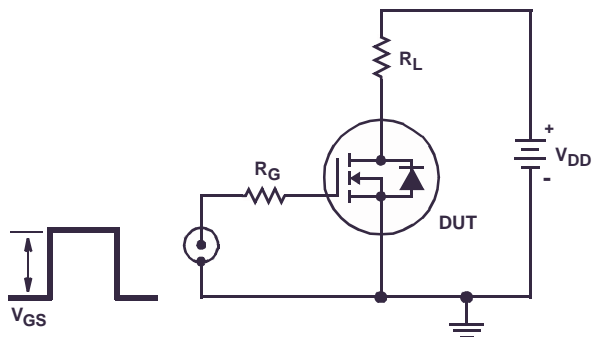

FIGURE 10. SWITCHING TIME TEST CIRCUIT

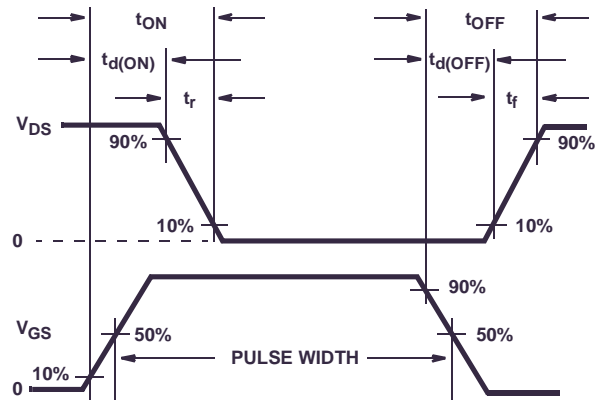

FIGURE 11. RESISTIVE SWITCHING WAVEFORMS

Test Circuits and Waveforms (Continued)

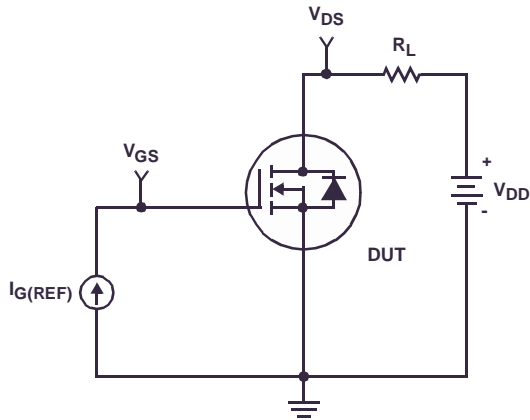

FIGURE 12. GATE CHARGE TEST CIRCUIT

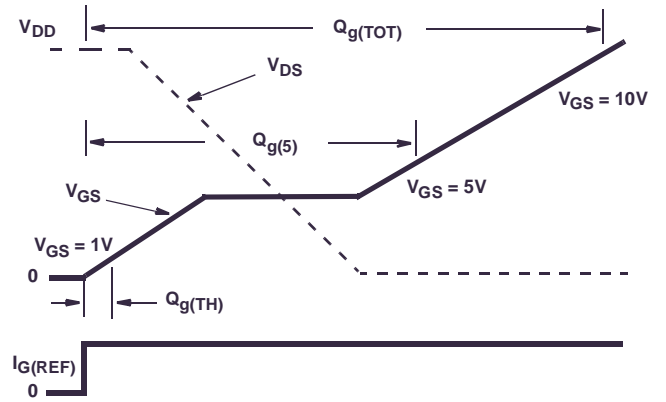

FIGURE 13. GATE CHARGE WAVEFORMS

## TRADEMARKS

The following are registered and unregistered trademarks Fairchild Semiconductor owns or is authorized to use and is not intended to be an exhaustive list of all such trademarks.

ACEx™	FACT Quiet Series™	LittleFET™	Power247™	SuperSOT™-3
ActiveArray™	FAST®	MICROCOUPLER™	PowerTrench®	SuperSOT™-6
Bottomless™	FASTr™	MicroFET™	QFET®	SuperSOT™-8
CoolFET™	FRFET™	MicroPak™	QS™	SyncFET™
CROSSVOLT™	GlobalOptoisolator™	MICROWIRE™	QT Optoelectronics™	TinyLogic®
DOMET™	GTO™	MSX™	Quiet Series™	TINYOPTO™
EcoSPARK™	HiSeC™	MSXPro™	RapidConfigure™	TruTranslation™
E <sup>2</sup> CMOST™	I <sup>2</sup> C™	OCX™	RapidConnect™	UHC™
EnSigna™	ImpliedDisconnect™	OCXPro™	SILENT SWITCHER®	UltraFET®
FACT™	ISOPLANAR™	OPTOLOGIC®	SMART START™	VCX™
Across the board. Around the world.™	OPTOPLANAR™	SPM™		
The Power Franchise™	PACMAN™	Stealth™		
Programmable Active Droop™	POP™	SuperFET™		

## DISCLAIMER

FAIRCHILD SEMICONDUCTOR RESERVES THE RIGHT TO MAKE CHANGES WITHOUT FURTHER NOTICE TO ANY PRODUCTS HEREIN TO IMPROVE RELIABILITY, FUNCTION OR DESIGN. FAIRCHILD DOES NOT ASSUME ANY LIABILITY ARISING OUT OF THE APPLICATION OR USE OF ANY PRODUCT OR CIRCUIT DESCRIBED HEREIN; NEITHER DOES IT CONVEY ANY LICENSE UNDER ITS PATENT RIGHTS, NOR THE RIGHTS OF OTHERS.

## LIFE SUPPORT POLICY

FAIRCHILD'S PRODUCTS ARE NOT AUTHORIZED FOR USE AS CRITICAL COMPONENTS IN LIFE SUPPORT DEVICES OR SYSTEMS WITHOUT THE EXPRESS WRITTEN APPROVAL OF FAIRCHILD SEMICONDUCTOR CORPORATION.

As used herein:

1. Life support devices or systems are devices or systems which, (a) are intended for surgical implant into the body, or (b) support or sustain life, or (c) whose failure to perform when properly used in accordance with instructions for use provided in the labeling, can be reasonably expected to result in significant injury to the user.
2. A critical component is any component of a life support device or system whose failure to perform can be reasonably expected to cause the failure of the life support device or system, or to affect its safety or effectiveness.

## PRODUCT STATUS DEFINITIONS

### Definition of Terms

Datasheet Identification	Product Status	Definition
Advance Information	Formative or In Design	This datasheet contains the design specifications for product development. Specifications may change in any manner without notice.
Preliminary	First Production	This datasheet contains preliminary data, and supplementary data will be published at a later date. Fairchild Semiconductor reserves the right to make changes at any time without notice in order to improve design.
No Identification Needed	Full Production	This datasheet contains final specifications. Fairchild Semiconductor reserves the right to make changes at any time without notice in order to improve design.
Obsolete	Not In Production	This datasheet contains specifications on a product that has been discontinued by Fairchild semiconductor. The datasheet is printed for reference information only.